

Introduction

Contacta HLD5 is a standalone dual hearing loop driver with integral phase shifter for perimeter or phased array configuration, suitable for smaller facilities including meeting rooms, classrooms and similar sized venues. Ultra efficient management of power enables the unit to be extremely compact.

Document Contents

1. Introduction
2. Phantom Power Selection
3. Adjustment Controls (Audio Input and Drive controls)
4. Input Connections
5. Output Configurations

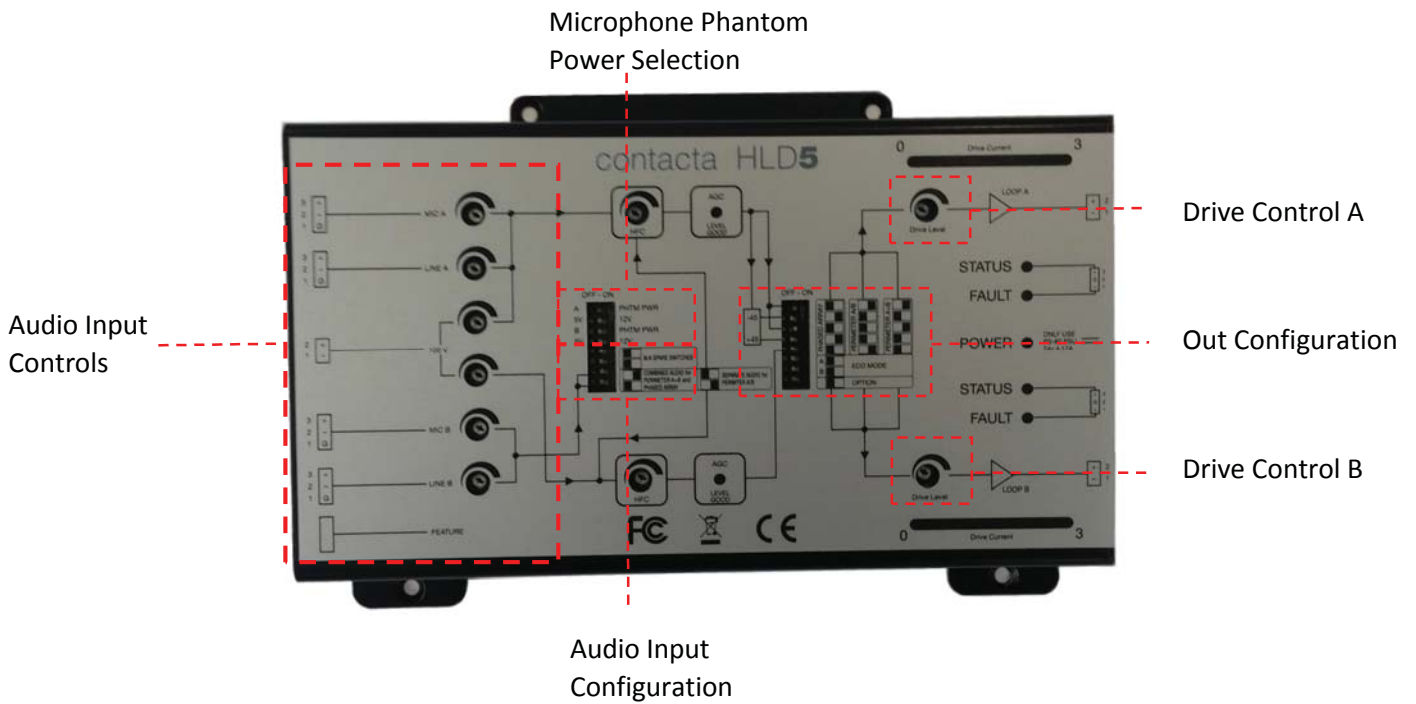

Phantom Power

The HLD5 has two dedicated microphone inputs one for channel A and one for channel B. Both inputs have selectable phantom power (5V or 12V). The phantom power selection is controlled from switches located on the front panel.

To enable Phantom Power the switches need to be set to the following positions:

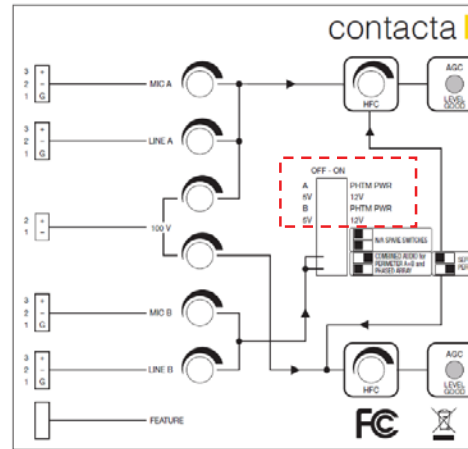

Channel A

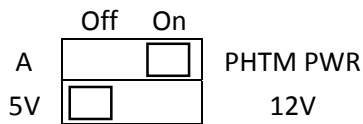

When the switches are in the positions shown above the phantom power for channel A is on and set to 5V.

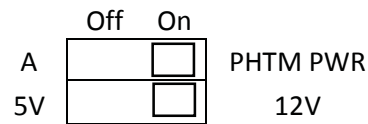

When the switches are in the positions shown above the phantom power for channel A is on and set to 12V.

Channel B

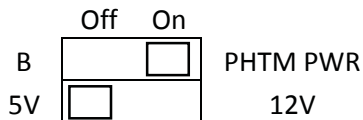

When the switches are in the positions shown above the phantom power for channel B is on and set to 5V.

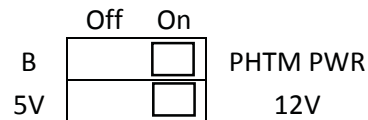

When the switches are in the positions shown above the phantom power for channel B is on and set to 12V.

Adjusting the HLD5

Having configured the HLD5 for the type of loop it is required to drive it is now time to adjust the level controls to achieve the desired loop current.

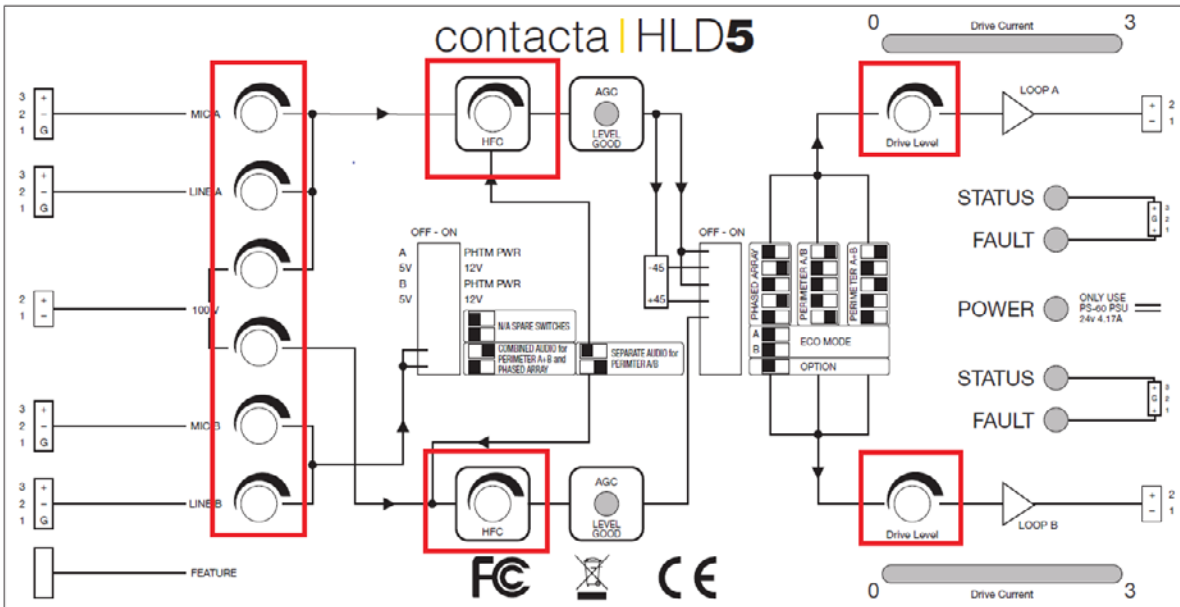

Figure 1

Figure 1 above shows the location of the adjustment controls on the HLD5.

Input level adjustments

Before applying power to the HLD5 make sure all the controls are fully counter clockwise.

Connect a source to the desired input on the HLD5 (see making connections section) and also connect a loop to the output.

Apply power to the HLD5 the drive current indicators will now light briefly the status and power indicators should be lit.

Slowly turn the control corresponding to the selected input clockwise until the level good indicator lights. When the Level good indicator lights this means that the AGC circuit is working correctly.

Output level adjustment

With the input level correctly adjusted the output current level can now be adjusted.

This is achieved by adjusting the drive level control clockwise until the desired loop current is reached.

Connecting to the HLD5

The following documents shows the recommend connections for the HLD5.

Input connections

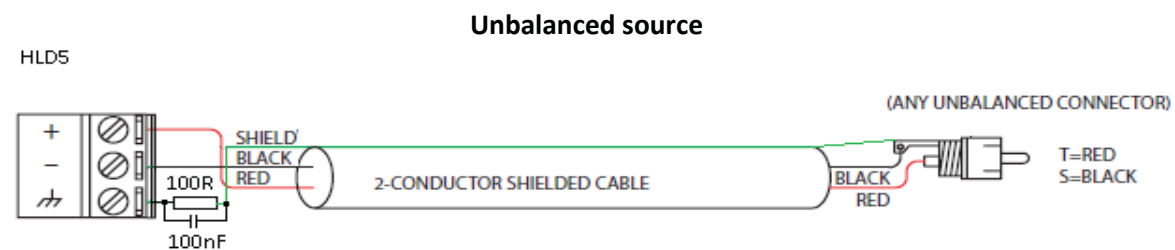
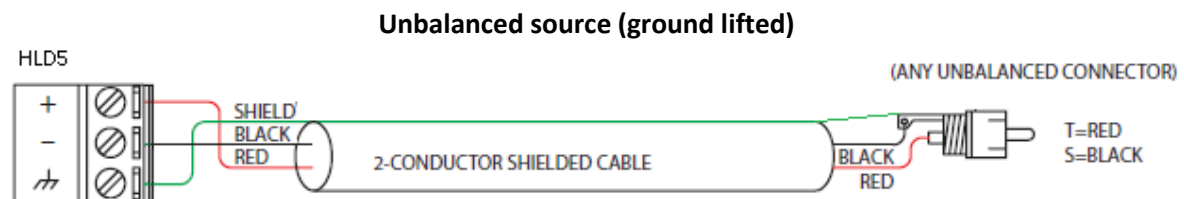
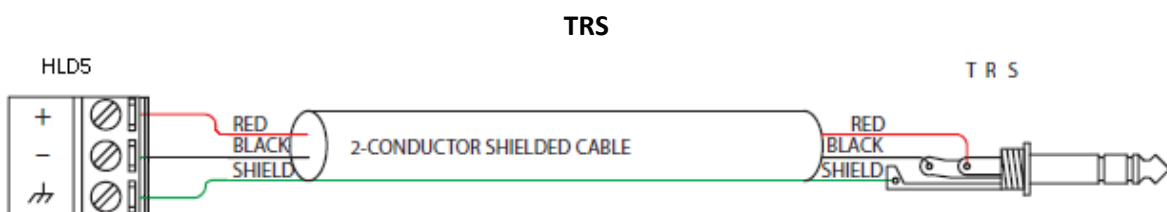
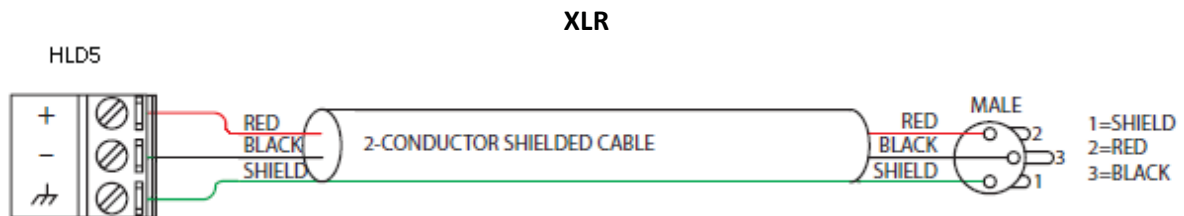

Output Connections

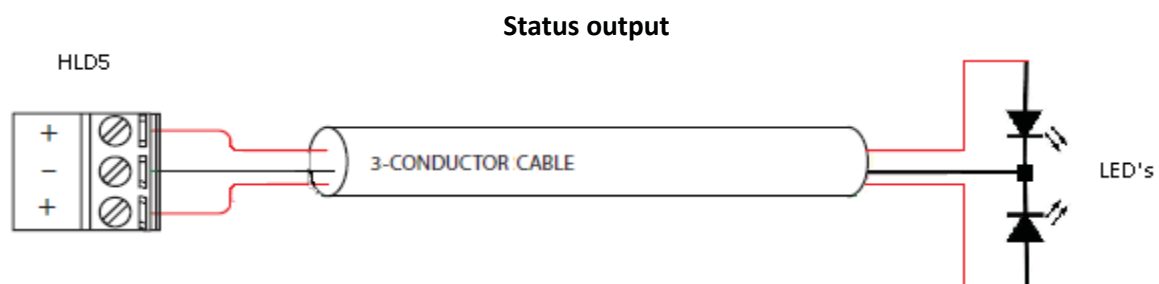
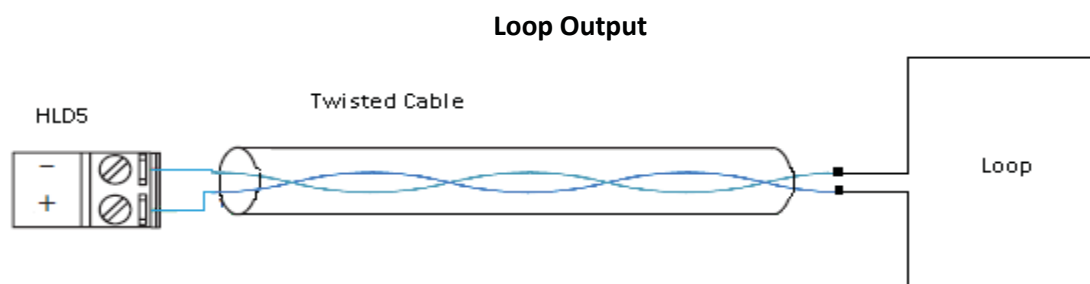

Configuring the HLD5 hearing loop driver

The HLD5 is extremely flexible in how the inputs and outputs can be configured.

There however 3 main configurations available that will cover most usage situations, these will be described below.

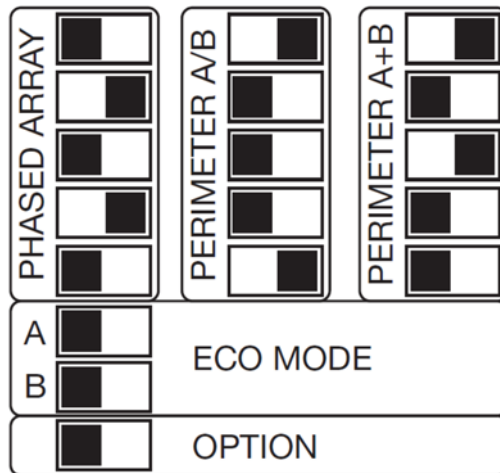
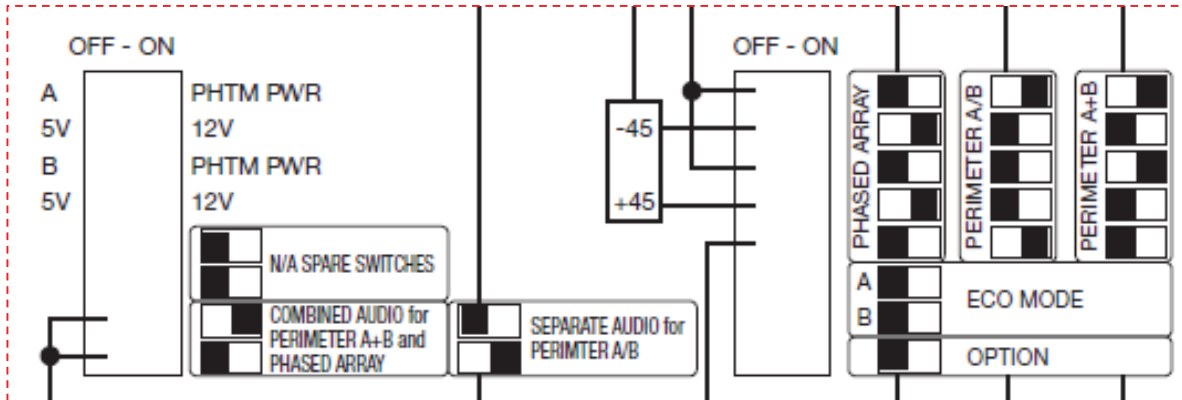

The configuration of the HLD5 is achieved by positioning switches located on the front panel as shown in figure 1 above.

Perimeter A/B Two separate Loops

This configuration is used when driving two separate loops from differing sources in different locations.

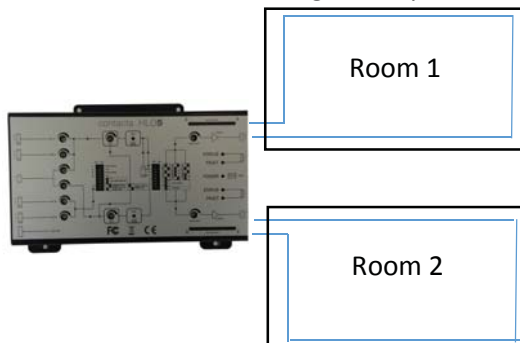

Perimeter A+B Parallel

This configuration is used when driving a perimeter loop in a single location where more current is required than a single loop can provide. It allows all the inputs to be used as a source

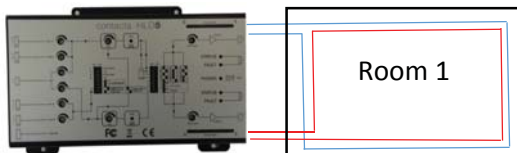

Phased Array

This configuration is used when driving a phased array loop in a single location. It allows all the inputs to be used as a source.

